







OB 2000

For heavy loads



Tech Specs

-  Weight: 9,6 kg
-  Payload: 0-140 kg
-  Material: Aluminium
-  Height range: 66 – 124 cm
-  Head fitting: Flat base
-  Transport length: 84 cm
-  1 stages

Dolly XL















- Weight: 6,8 kg
- Payload: 140 kg
- Height: 19 cm
- Build Radius: 49 cm

Video 75 Plus Studio

The multi-talent for studio operation



Tech Specs

-  Weight: 14.6 kg
-  Payload: 12 – 85 kg
-  24 counterbalance steps + boost button
-  9 horizontal and vertical grades of drag, +0
-  Tilt range: +80° to -60°
-  Slide range: 145 mm
-  Temperature range: -40° – 60°c
-  Camera fitting: V Plate
-  Head fitting: Flat base
-  Pan bar type / number: 2 pan bar front sections
-  Level: Illuminated
-  Adapter viewfinder extension: Optional

Features

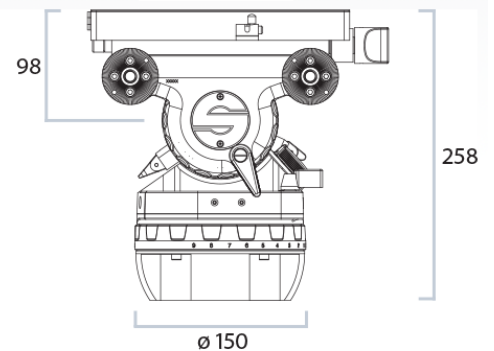

flat base (half ball with adapter)

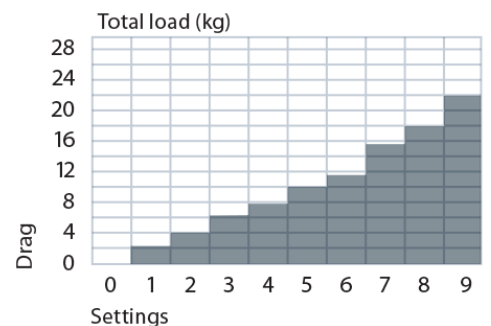
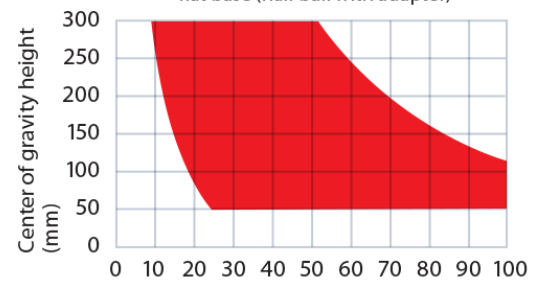

Video 75 Plus Studio

Fluid Head

Fluidkopf



sachtler

© by sachtler®. Alle Rechte vorbehalten / All rights reserved

Version: 3.1/09/14

Ausgabedatum / Issue date: 09/14



Bestellnr. / Order no.: sko16t120a

Originalbetriebsanleitung/Original User Manual

We want you to receive
Sachtler products that are
always state of the art.

Wir wollen, dass Ihre
Sachtler Produkte immer auf
dem aktuellsten Stand sind.

Therefore we reserve the
right to make changes based
on technical advances.

Deswegen behalten wir uns
technische Änderungen vor.

sachtler®
Vitec Group Videocom Division
www.vitecgroup.com

Erfurter Strasse 16
D-85386 Eching
Germany
Telefon: (+49) 89 321 58 200
Telefax: (+49) 89 321 58 227
E-Mail: contact@sachtler.de
Homepage: <http://www.sachtler.com>

Postfach / P.O.BOX 2039
D-85380 Eching
Germany

EC - Declaration of Conformity EG - Konformitätserklärung

Here we declare that this product complies with the requirements of the applied directives, standards and regulations for safety and health, if used for its intended application.

This declaration becomes invalid, if any changes have been made without our agreement.

Hiermit erklären wir, dass das hier genannte Produkt aufgrund seiner Bauart in der von uns in Verkehr gebrachten Ausführung den Sicherheits- und Gesundheitsanforderungen der zugrundeliegenden hier genannten EG - Richtlinien und der genannten Normen entspricht.

Bei einer nicht mit uns abgestimmten Änderung an diesem Produkt verliert diese Erklärung ihre Gültigkeit.



sachtler

Product / Produkt:

Video 75 Plus EFP, Studio

Components / Komponenten:

Code number (s) / Codenummer(n):

7500, 7501

Year of first manufacturing / Ab Baujahr:

2003

EC – Directives: **2004/108/EG**
EG – Richtlinien:

**Electromagnetic Compatibility /
Elektromagnetische Verträglichkeit**

Standards and Regulations:
Normen und Vorschriften:

EN 55103-1:2006-07
EN 55103-2:2006-07

Inspector / Prüfstelle:

Vitec Videocom GmbH

Date of Inspection / Prüfdatum:

2010-06

Eching, 08.11.2012

Alan Platt
R&D Director



Vitec Videocom GmbH
Headquarters
Erfurter Straße 16
85386 Eching
Germany

T +49 89 321 58 200
F +49 89 321 58 227
info@vitecvideocom.com
www.vitecvideocom.com

Bags
Petrol Bags
Camera accessories
OConnor
Equipment rentals UK
The Camera Store
Lighting
Anton/Bauer
Litepanels
Sachtler
Mobile power
Anton/Bauer
Promoters
Autoscript
Supports
OConnor
Sachtler
Vinten
Vinten Radamec

4 Technical specifications

4.1 General data

Counterbalance:	24 steps + Boost Button
Balance plate:	145 mm (5.7") sliding range
Grades of drag:	horizontally and vertically 9 each and 0
Tilt angle:	+80° / -60°
Panning range:	360°
Temperature range:	-40°C (-40°F) to 60°C (104°F)
Weight:	14.6 kg (32.2 lbs)
Max. load:	12 - 85 kg (26 - 187 lbs) @ 200 mm (8") cog 14.0 - 81.4 kg (30.8 - 179.4 lbs) @ 150 mm (6") cog
Camera fitting:	Sideload plate S
Tripod / Pedestal fitting:	integrated flat base for all OB tripods and Multi Disc for Quickfix and Sachtler pedestals, respectively
Pan bars:	two front sections with a diameter of 28.5 mm (1.1"), length 400 mm (15.7")
Batteries:	3 each 625 U or LR9

4.2 Dimensions

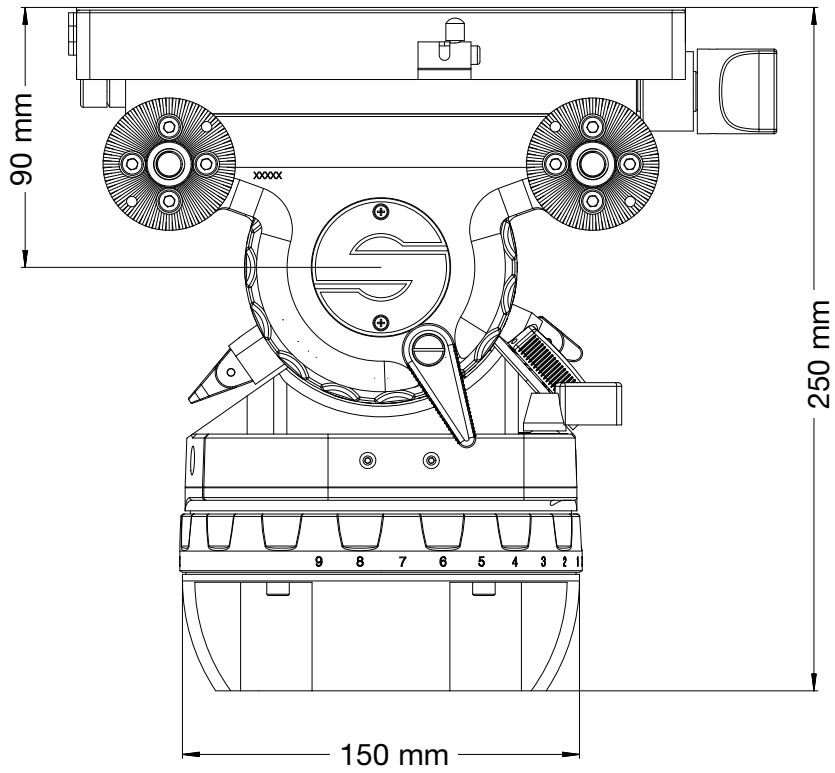

4 Technische Daten

4.1 Allgemeine Daten

Gewichtsausgleich:	in 24 Stufen + Boost Button
Balanceplatte:	145 mm Verschiebebereich
Dämpfungsstufen:	je 9 horizontal und 9 vertikal und 0
Neigebereich:	+80° / -60°
Schwenkbereich:	360°
Temperaturbereich:	-40° C bis 60° C
Eigengewicht:	14,6 kg
Traglast:	12 - 85 kg @ 200 mm cog 14.0 - 84.4 kg @ 150 mm cog
Kameraanschluß:	Sideload plate S
Stativanschluß:	integrierter Flachboden für alle AÜ- Stative bzw. Multi Disc für Quickfix und Sachtler Pedestale
Schwenkarme:	zwei vordere Schwenkarme mit Befestigungsdurchmesser 28,5 mm, Länge 400 mm
Batterien:	3 Stück 625 U oder LR9

4.2 Abmessungen

