

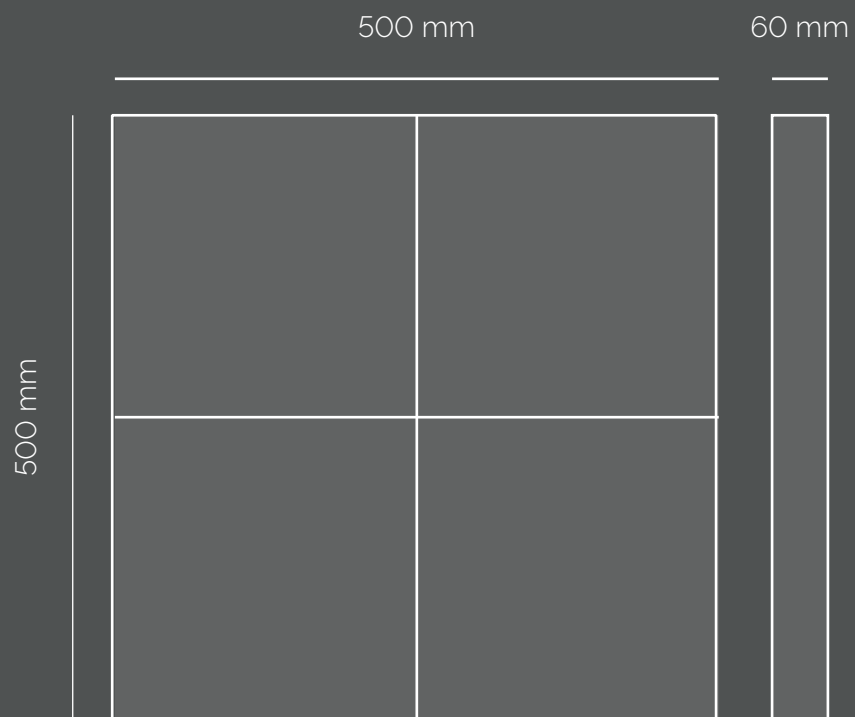

AURA

Dimensions	1
Drawing	2
Build Option	3
Build Option cornered	4
Build Option curved	6
Build Option staqon	7
Controller & Converter	8
Product Line	9
Cabinet Corner	10
Maintenance	11
Maintenance Case	12
Add-on	13
Mini LED in Package	14
Specifications	15



Each cabinet is **500 x 500 mm** and **60 mm** deep.
It is compatible with stacking for fairs.

Four easily replaceable modules make up one cabinet. These are attached magnetically to the frame. Further details can be found on the drawing on the next page.



8.9 kg/cabinet; 35.6 kg/m²



160° horizontal; 160° vertical

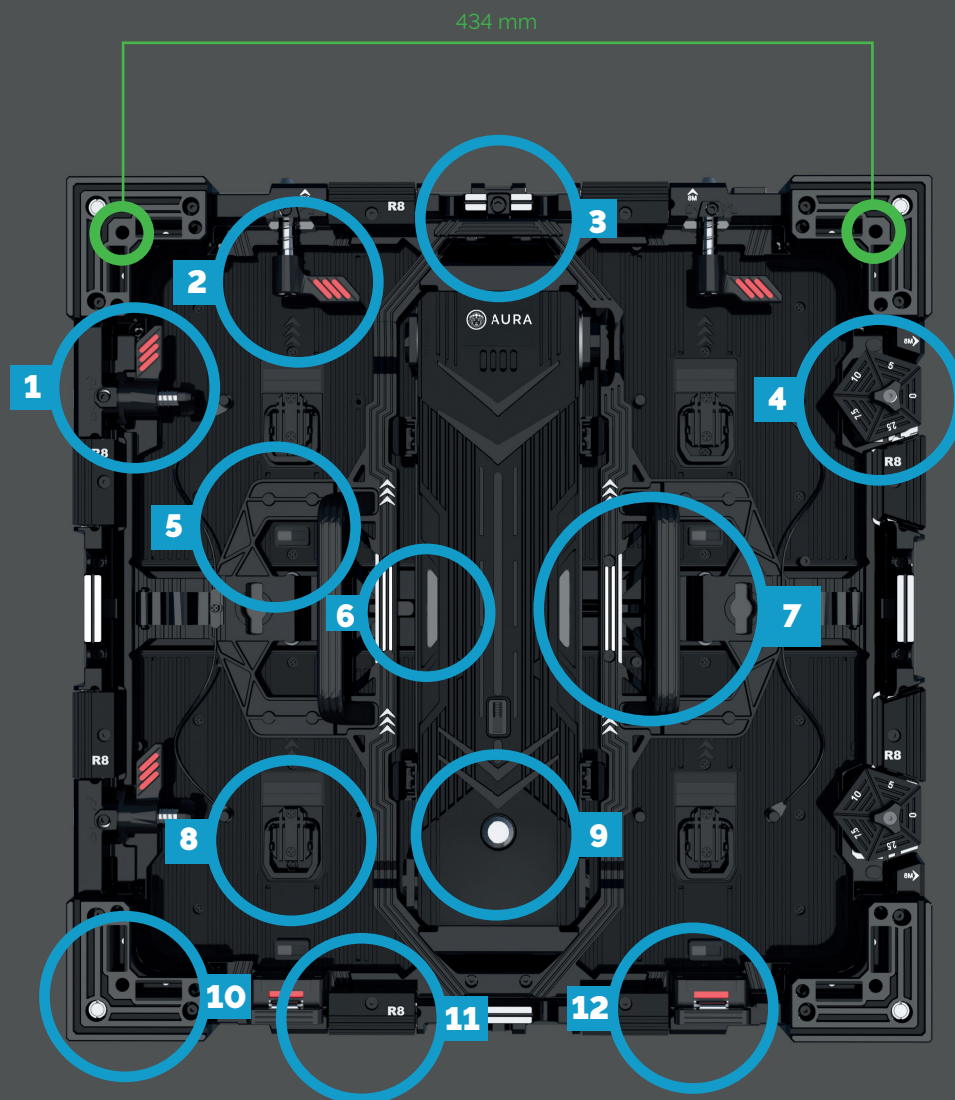

- 1 Side Lock
- 2 Top Lock
- 3 Top Handle
- 4 Curving Lock
- 5 Toggle to mark defective Modules
- 6 Status Lamp
- 7 Side Handle
- 8 Module Handle
- 9 Test Button
- 10 500 Corner
- 11 Adapter Fair Stacking System
- 12 Locking Status

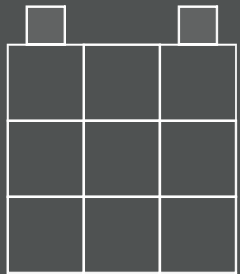

HANGING

18 Cabinets

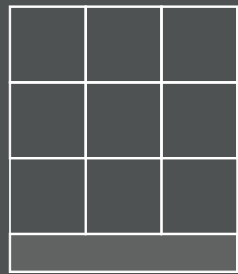

STACKING

12 Cabinets

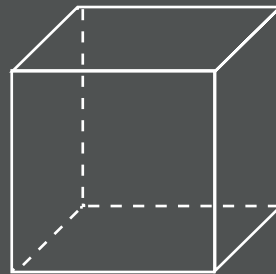

VARYING SHAPES

With 45° and 90° corner cabinets

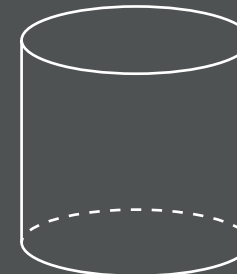

CURVED

Up to 30° concave/convex in 1° steps

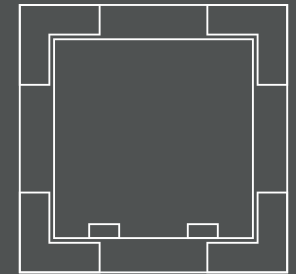

STAGON

Suitable for exhibitions

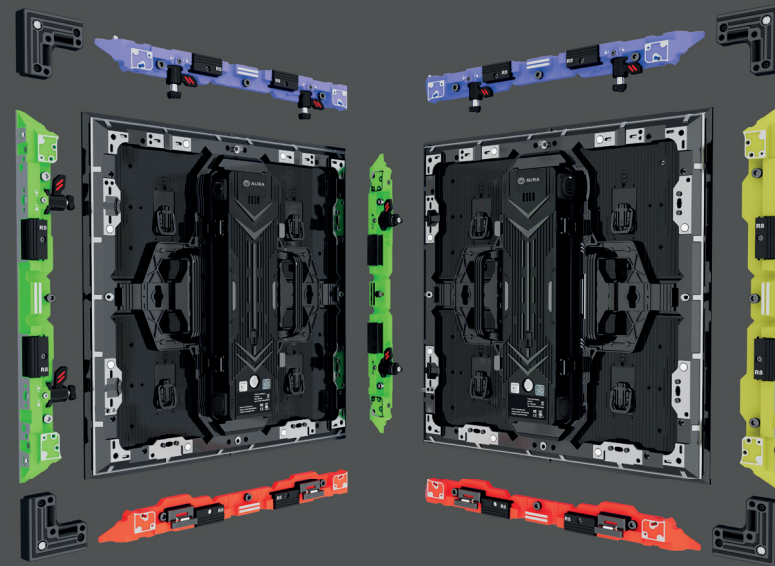
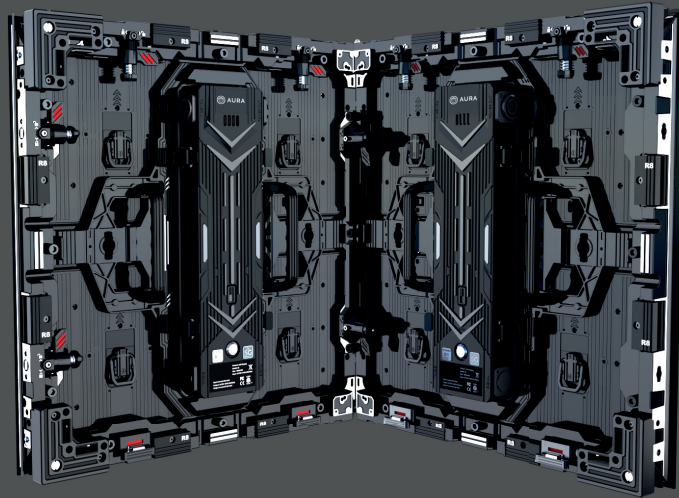

AURA MAKES VARIOUS SHAPES AND FORMS POSSIBLE!

AURA 45° cabinets can be combined with 90° cabinets or curved material to make your visions come to life. With the use of corner fillers you can turn your 45° cabinets into 90° cabinets, making them extremely versatile.

90° concave and convex cabinets make perfect 90° corners possible in your LED walls.

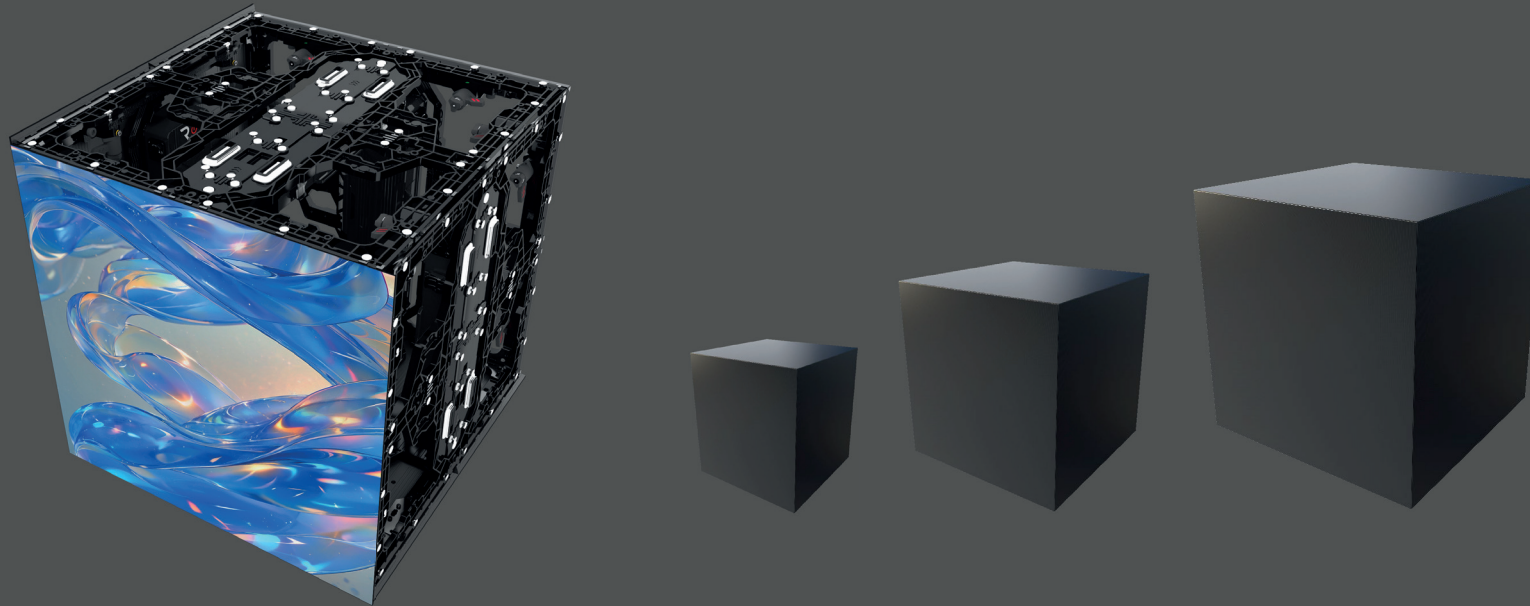

CUBE CONNECTOR

Thanks to specifically designed cube connectors, 90° cubes are easily applicable with AURA.

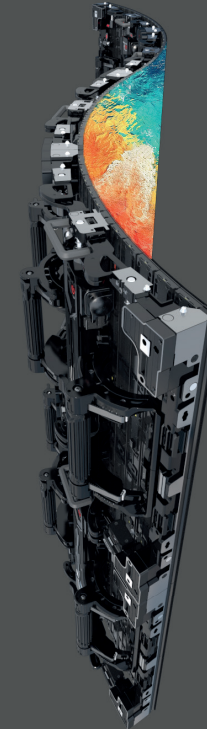
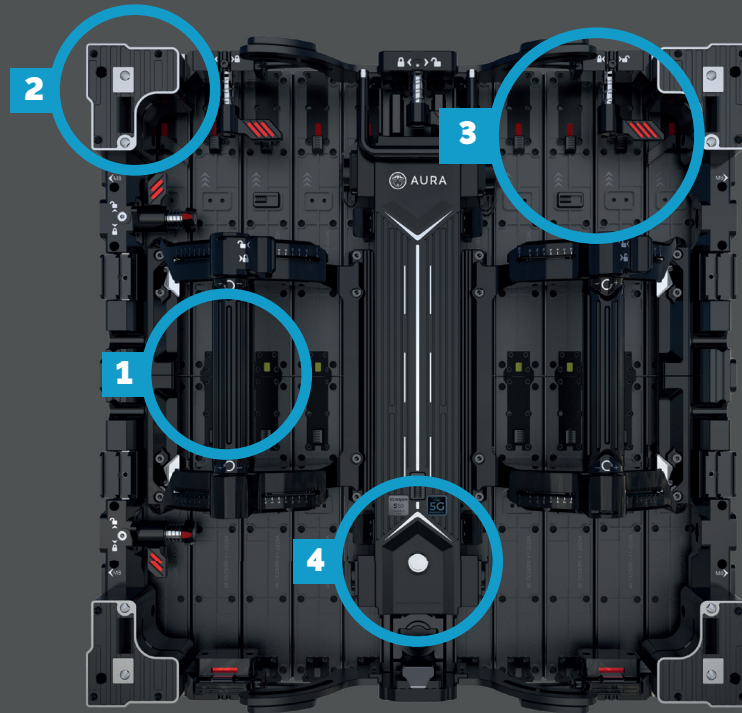

AURA CURVED REAR VIEW

- 1 Curving Handles
- 2 500 Corner
- 3 Pins for Z-Axis Alignment
- 4 Test Button



STAQON

Staqon is an innovative new modular LED frame system. It is flexible, robust, incredibly easy to use and provides the perfect solution for creative trade show booths, events or fixed installations. Offering metric dimensions, simple connections and a wide range of design options.

NOVASTAR	CX40-Pro	MX2000 Pro	MX6000 Pro
INPUT	HDMI 2.0, DP 1.2, 12G-SDI	HDMI 2.0, DP 1.2, 12G-SDI, SMPTE ST 2110	HDMI 2.0/2.1, DP 1.2/1.4, 12G-SDI, SMPTE ST 2110
SUPPORTED RESOLUTION	4096 x 2160 @60 Hz (max)	4096 x 2160 @60 Hz or 8192 x 1080 @60 Hz (forced)	4096 x 2160 @60 Hz or 8192 x 1080 @60Hz (forced)



LED CONTROLLER

Due to its new Novastar **5G** XA50 Pro receiving card, AURA is capable of delivering images at **16 bit depth** and grey scale along with a refresh rate of **7860 Hz**. This greatly reduces the amount of cables needed.

Fibre converters are a cost-effective way of conversion between optical and electrical signals for video sources to connect the sending card to the LED display. It is easy to install on-site and offers stable long-distance transmission. The fibre converter **CVT8-5G** is a must-have when working with the MX2000 Pro or MX6000 Pro.



AURA

Standard cabinet 500 x 500 mm
 Corner cabinet 45° left/right 500 x 500 mm

Corner cabinet 90°
 Concave 296.98 x 500mm
 Convex 227.26 x 500 mm

Cube cabinet 500 x 500 mm
 Curved cabinet 500 x 500 mm

HANGING & STACKING SYSTEM

Basement/truss
 AURA sledge to adapt to your preexisting system
 AURA stacking clamp

CASE

With inlays for eight AURA cabinets individual inlays for standard-issue cable cases

ACCESSORIES

Shims to adjust thickness for different frames
 Cube connector
 Corner filler

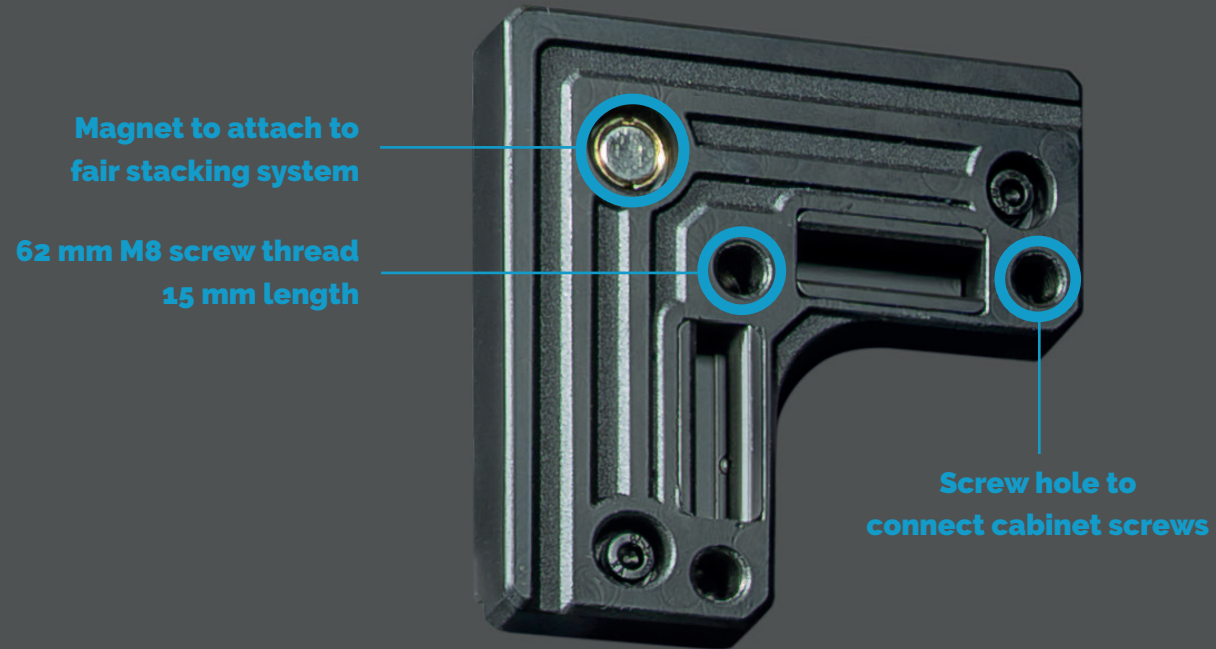

CABINET CORNER

AURA comes with M8 screw holes and magnets to connect with varying frame and stacking systems.

FRONT MAINTENANCE

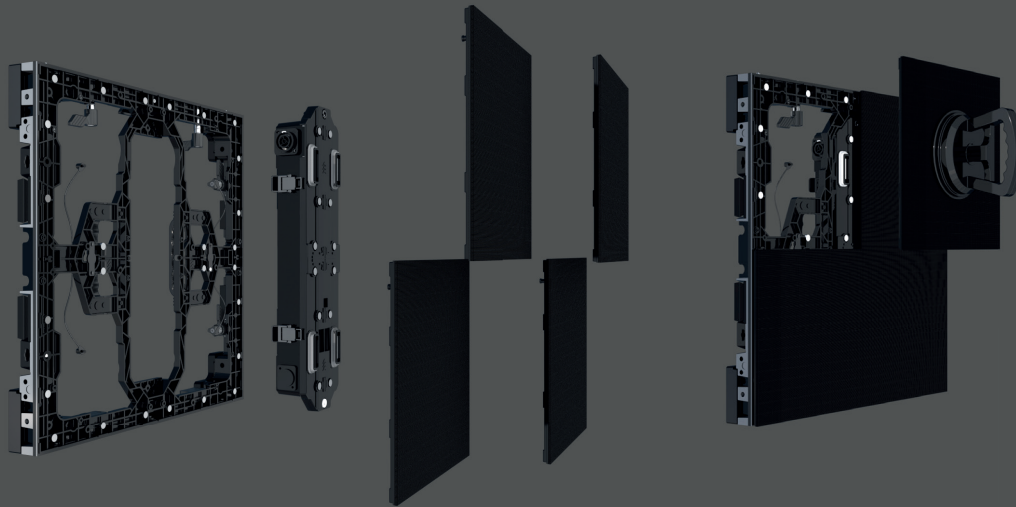

BACK MAINTENANCE

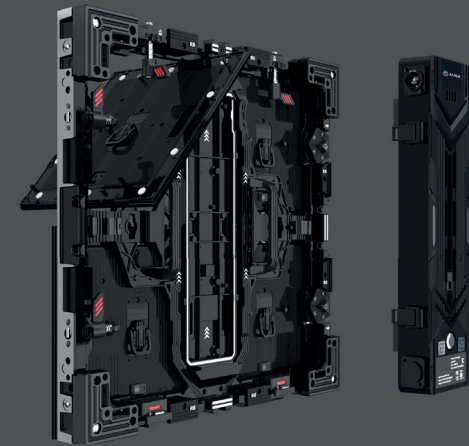

MAINTENANCE

Front and back maintenance is possible with AURA cabinets. Due to its matte finish, which offers deep black values with a low reflection, it is best to handle the cabinets with gloves to avoid fingerprints. These can easily be wiped away with a little bit of water and a microfibre cloth. Erasers and dish soap can be used for tough stains. Do not use alcohol or anything with additives!



We offer two cases for easy on-the-go maintenance. A version that is designed to work perfectly with a 4K wall respectively. They consist of:

- 20 x Modules (4K)
- 5 x Power Box (4K)
- 5 x Powercon True1 (4K)
- 1 x Removal Tool
- 1 x Z-Axis Tool
- 1 x Gloves
- 1 x Laptop

- 1 x Spray Bottle for distilled Water
- 1 x Microfibre Cloth
- 1 x Eraser
- 1 x Dish Soap



ADDITIONAL LANG BENEFITS

Especially when it comes to installations in high-risk spaces (i.e. airports), fire safety is key. We offer to upgrade your LED cabinets with the latest Media Fire Protect technology done in-house.

We add a mini-fire-extinguisher into the power box to swiftly detect and extinguish fire and smoke.



- Dust-proof
- Anti-UV
- High/Low Temperature
- Eye Safety
- Water-resistant
- Humidity Proof
- Anti-static
- Robust
- Shock-proof

WHY WE CHOSE MIP TECHNOLOGY FOR AURA

AURA makes bright images up to 1,500 nits possible using Flip Chip mounting techniques and a Common Cathode configuration, simultaneously offering high black and grey scale uniformity. The flexibility of the MiniLED material makes curved cabinets at a variance of angles possible. The LEDs are protected with a water- and shock-resistant glue coating that makes the cabinets highly versatile and durable. In the rare case of a damaged pixel, this can be repaired in-house at LANG AG.



Model designation	AURA
Pixel pitch	1,56 mm
Brightness	1,500 nits, HDR
Application area	Indoor
Pixel density	320 x 320 px/Cabinet; 410,914 px/m ²
LED-type	MIP (MiniLED in Package), CCT (Common Cathode Technology), GOB (Glue on Board), Flip Chip
Lifespan LED	100,000 hours
Viewing angle	160° horizontal; 160° vertical
Processing	Novastar, XA50 Pro (5G) Receiving Card
Bit depth	16 bit
Refresh Rate	7,680 Hz
Scan Rate	1/16
Power consumption	Maximum: 112,5 W/Cabinet; 450 W/m ² Average: 37,5 W/Cabinet; 150 W/m ²
Input voltage	100 - 240 V / 50 - 60 Hz
Operating temperature	0 to +45 °C
Humidity operating	10 to 90 %
Cabinet dimensions	500 x 500 x 60 mm (W x H x D); (= 0,25 m ²)
Max. Overall height (hanging/standing)	18 Cabinets / 12 Cabinets
Weight	8,9 kg/Cabinet; 35,6 kg/m ²
Maintenance	Front/Back Service
Curving	0°; 2,5°; 5,0°; 7,5°; 10,0° (max) concave
Protection	IP43 (front) / IP30 (back)
Certification	CE, RoHS, EMC class B, TÜV